

3-INPUT / 2-INPUT VIDEO SWITCH

■ GENERAL DESCRIPTION

The **NJM2506** is video switch for video and audio signal. It contains 3 input-1 output and 2 input-1 output video switch. 3 input-1 output switch has clamp function and so is applied to fixed DC level of video signal. Its operating voltage is 4.75 to 13V and bandwidth is 10MHz. Crosstalk is 75dB (at $f = 4.43\text{MHz}$)

■ PACKAGE OUTLINE

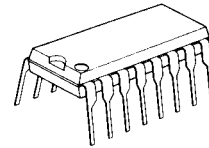

NJM2506D

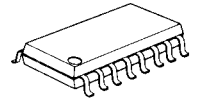

NJM2506M

■ FEATURES

- Wide Operating Supply Range (+4.75V to +13V)
- 3 Input-1 Output and 2 Input-1 Output
- Internal Clamp Function
- Crosstalk 75dB (at 4.43MHz)
- Wide Frequency Range 10MHz (2V_{P-P} Input)
- Package Outline DIP16, DMP16
- Bipolar Technology

■ RECOMMENDED OPERATING CONDITION

- Operating Voltage V^+ 4.75V to 13.0V

■ APPLICATION

- VCR, Video Camera, AV-TV, Video Disk Player.

■ BLOCK DIAGRAM

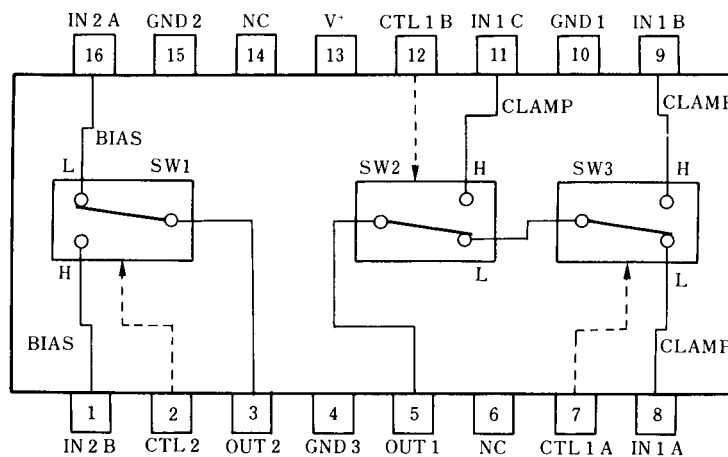

NJM2506D

NJM2506M

NJM2506

■ ABSOLUTE MAXIMUM RATINGS

($T_a = 25^\circ\text{C}$)

| PARAMETER | SYMBOL | RATINGS | UNIT |
|-----------------------------|-----------|----------------------------|------------------|
| Supply Voltage | V^+ | 14 | V |
| Power Dissipation | P_D | (DIP16) 700 (DMP16) 350 | mW mW |
| Operating Temperature Range | T_{opr} | -40 to +85 | $^\circ\text{C}$ |
| Storage Temperature Range | T_{stg} | -40 to +125 | $^\circ\text{C}$ |

■ ELECTRICAL CHARACTERISTICS

($V^+ = 5\text{V}, T_a = 25^\circ\text{C}$)

| PARAMETER | SYMBOL | TEST CONDITION | MIN. | TYP. | MAX. | UNIT |
|---------------------------|-----------|--|------|------|------|------|
| Operating Current (1) | I_{CC1} | $V^+ = 5\text{V}$ (Note1) | 6.7 | 9.7 | 12.7 | mA |
| Operating Current (2) | I_{CC2} | $V^+ = 9\text{V}$ (Note1) | 8.6 | 12.3 | 16.0 | mA |
| Voltage Gain | G_V | $V_I = 2V_{P.P.}/100\text{kHz}, V_O / V_I$ | -0.6 | -0.1 | +0.4 | dB |
| Frequency Response | G_f | $V_I = 2V_{P.P.}, V_O$ (10MHz / 100kHz) | -1.0 | 0 | +1.0 | dB |
| Differential Gain | DG | $V_I = 2V_{P.P.}$, Staircase Signal | - | 0.3 | - | % |
| Differential Phase | DP | $V_I = 2V_{P.P.}$, Staircase Signal | - | 0.3 | - | deg |
| Output offset Voltage (1) | V_{OS1} | (Note2) | -10 | 0 | +10 | mV |
| Output offset Voltage (2) | V_{OS2} | (Note2) | -30 | 0 | +30 | mV |
| Crosstalk | CT | $V_I = 2V_{P.P.}, 4.43\text{MHz}, V_O / V_I$ | - | -75 | - | dB |
| Switch Change Voltage | V_{CH} | All inside SW : ON | -2.5 | - | - | V |
| Switch Change Voltage | V_{CL} | All inside SW : OFF | - | - | 1.0 | V |

(Note1) : $S1 = S2 = S3 = S4 = S5 = S6 = S7 = 1$

(Note2) : Output DC Voltage Difference is tested on $S6 = 1 \rightarrow 2, S1 = S2 = S3 = S4 = S5 = 1, S8 = 2$ and $S7 = 1$

(Note3) : Output DC Voltage Difference is tested on $S6 = 1 \rightarrow 2, S7 = 1$ (or $S6 = 1, S7 = 1 \rightarrow 2,$), $S1 = S2 = S3 = S4 = S5 = 1$ and $S8 = 1$

■ TEST CIRCUIT

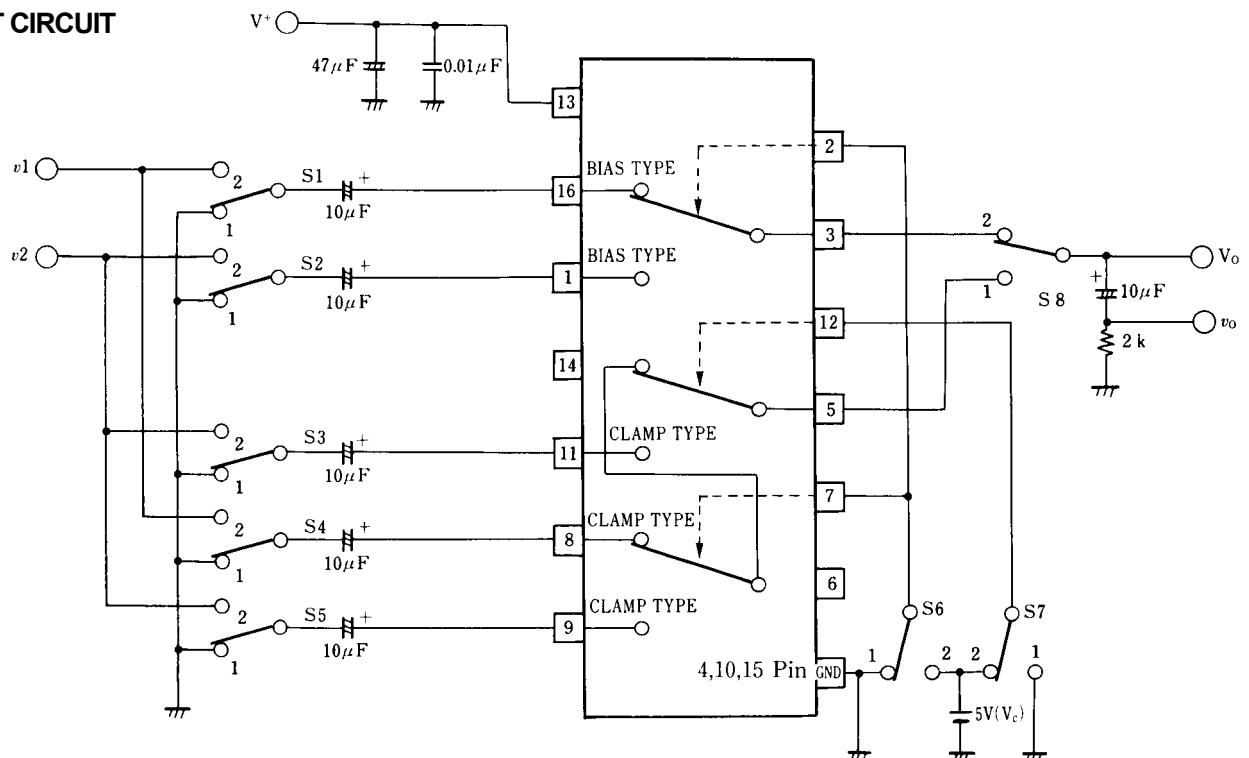

■ PIN FUNCTION

| PIN No. | PIN NAME | DC VOLTAGE | INSIDE EQUIVALENT CIRCUIT |
|---------------|--|------------|---------------------------|
| 16 1 | IN 2A IN 2B [Input] | 2.5V | |
| 8 9 11 | IN 1A IN 1B IN 1C [Input] | 1.5V | |
| 7 12 2 | CTL 1A CTL 1B CTL 2 [Control] | | |
| 5 | OUT1 [Output] | 1.8V | |
| 3 | OUT2 [Output] | 0.8V | |
| 13 | V ⁺ | 5V | |
| 15 4 10 | GND 1 GND 2 GND 3 | | |

■ TYPICAL CHARACTERISTICS (Ta = +25°C)

Operating Current vs. Operating Voltage

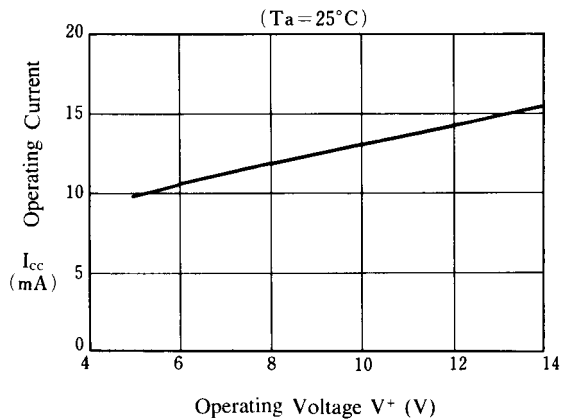

Operating Current vs. Ambient Temperature

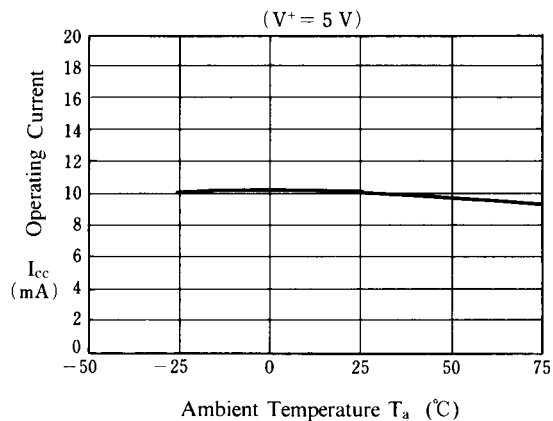

Operating Current vs. Ambient Temperature

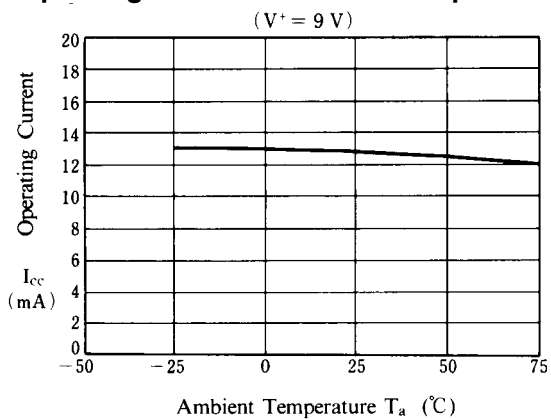

Voltage Gain vs. Operating Voltage

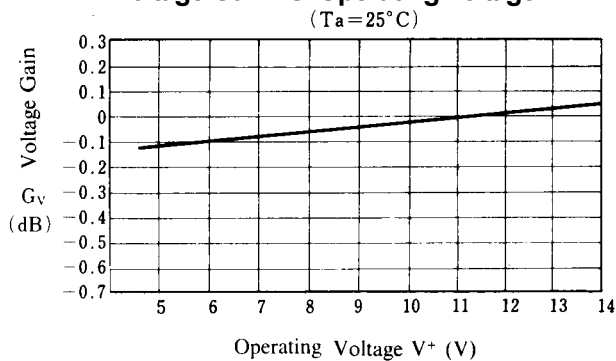

Voltage Gain vs. Frequency

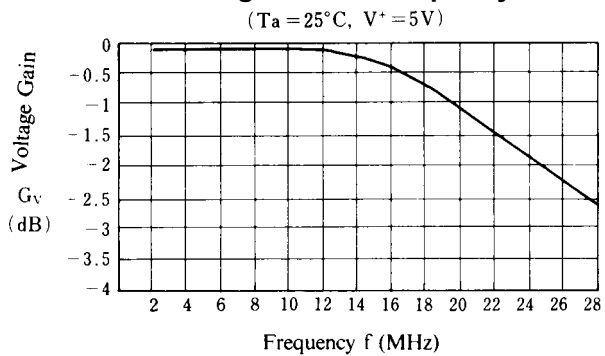

Voltage Gain vs. Ambient Temperature

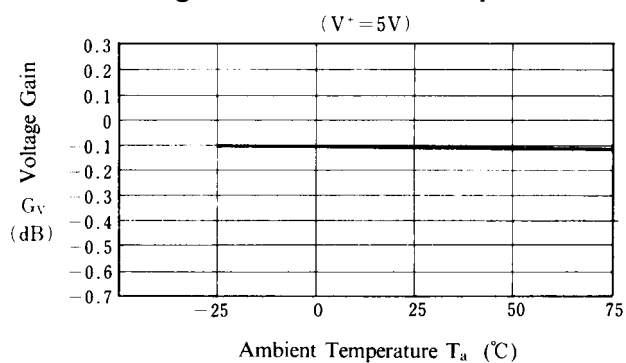

■ TYPICAL CHARACTERISTICS ($T_a = +25^\circ\text{C}$)

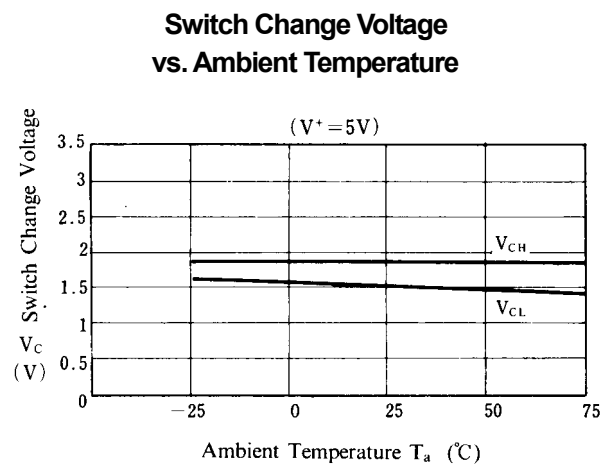
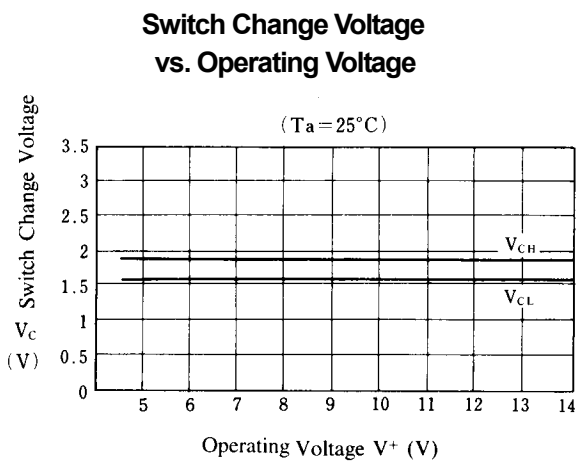
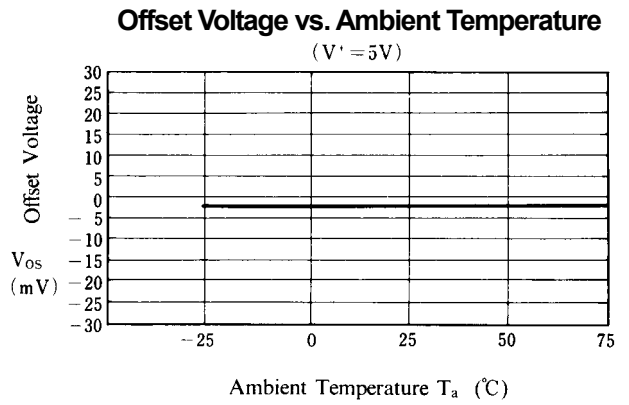
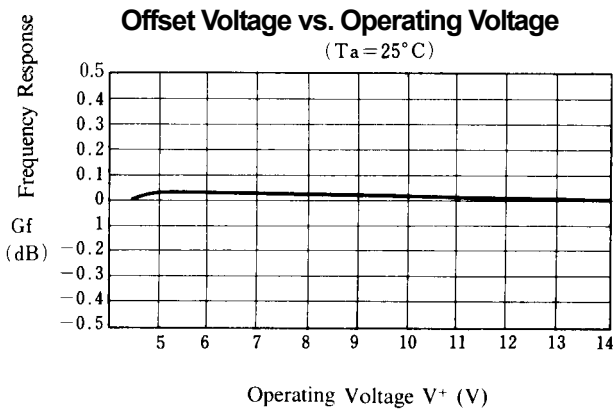
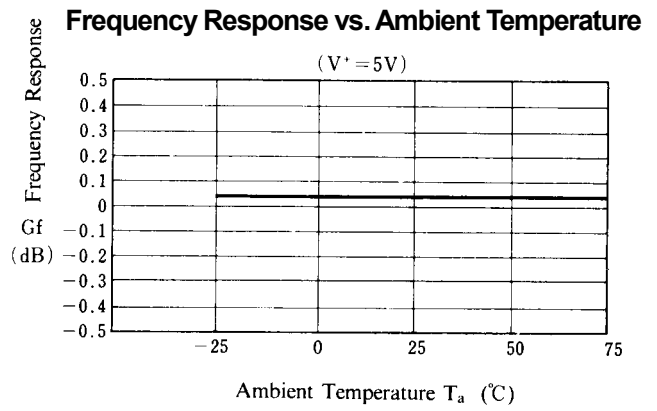
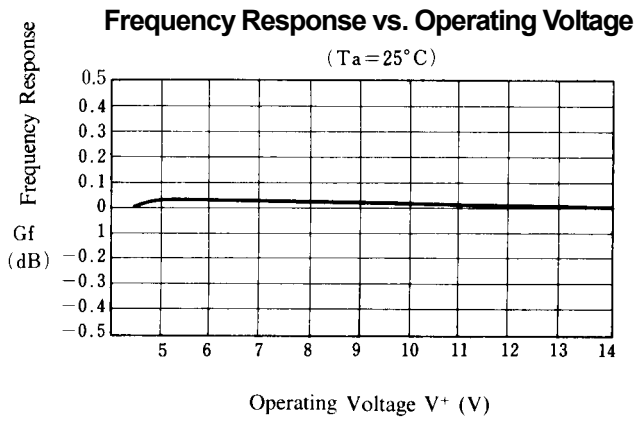

■ TYPICAL CHARACTERISTICS (Ta = +25°C)

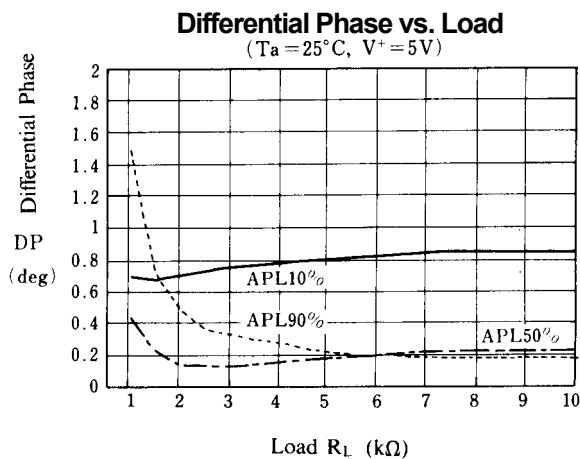
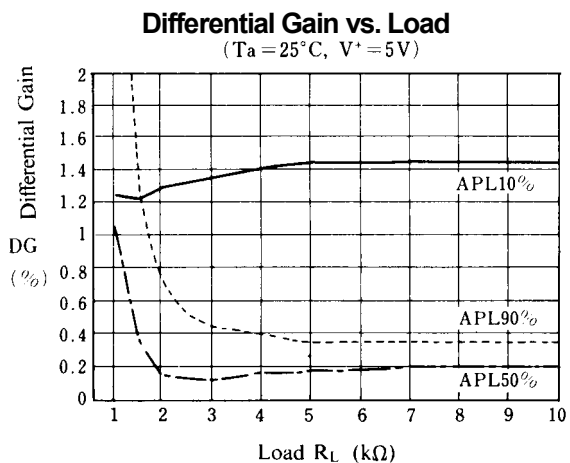
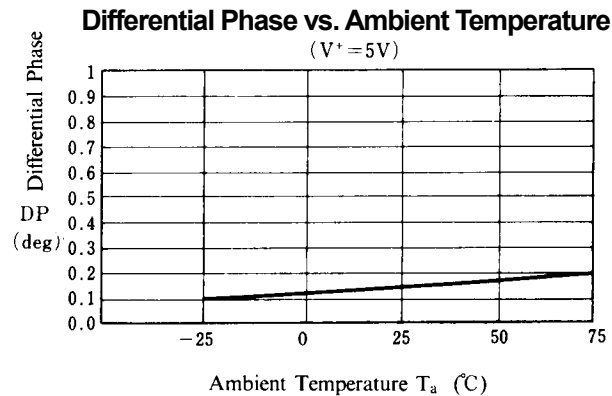
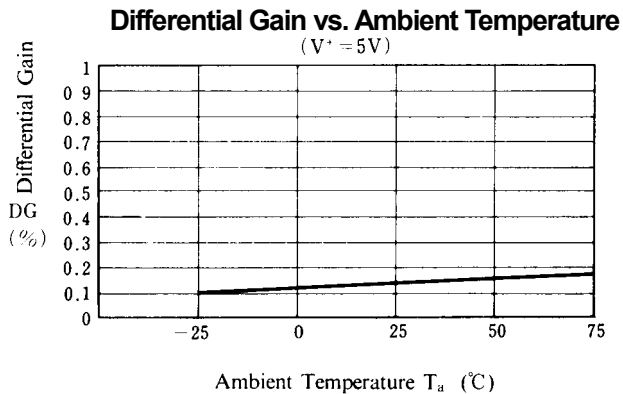
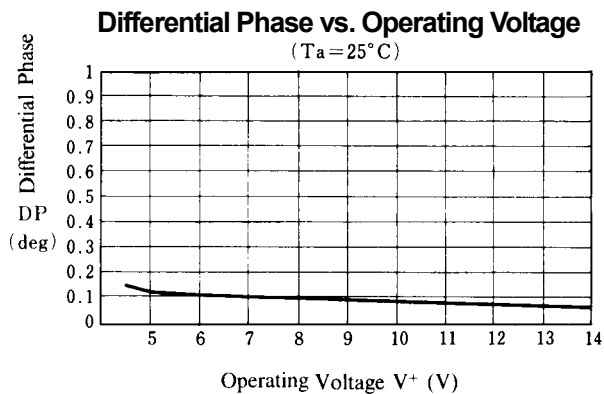
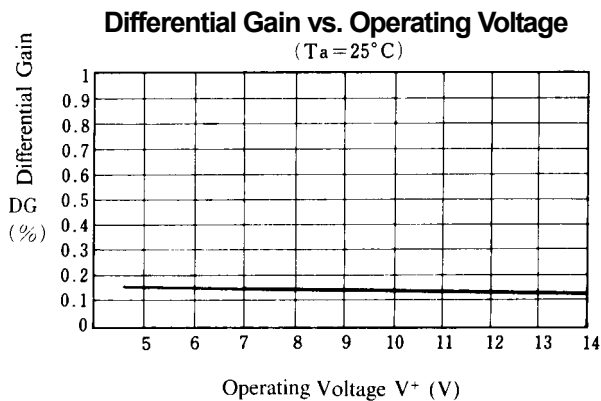

■ TYPICAL CHARACTERISTICS (Ta = +25°C)

Differential Gain vs. APL

(Ta = 25°C, V+ = 5V)

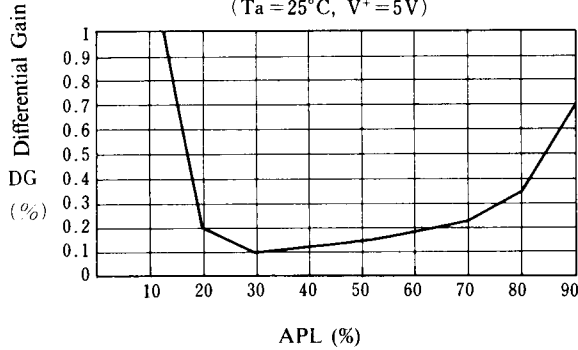

Differential Phase vs. APL

(Ta = 25°C, V+ = 5V)

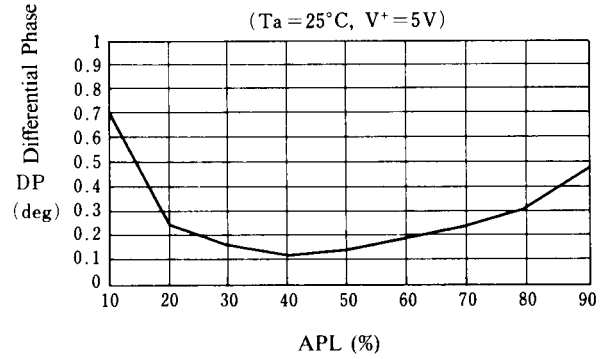

Differential Gain vs. Load

(Ta = 25°C, V+ = 5V)

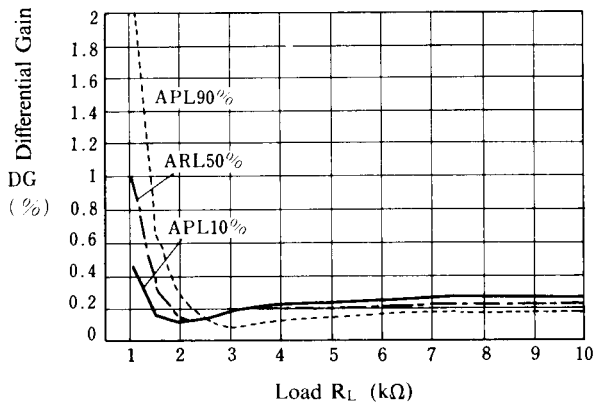

Differential Phase vs. Load

(Ta = 25°C, V+ = 5V)

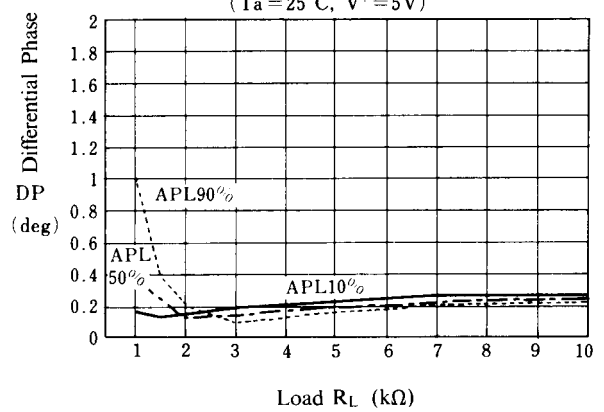

Differential Gain vs. APL

(Ta = 25°C, V+ = 5V)

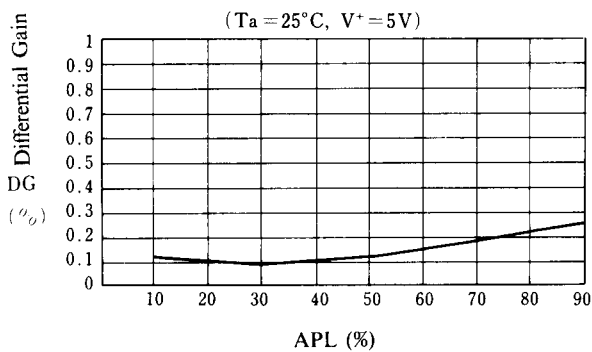

Differential Phase vs. APL

(Ta = 25°C, V+ = 5V)

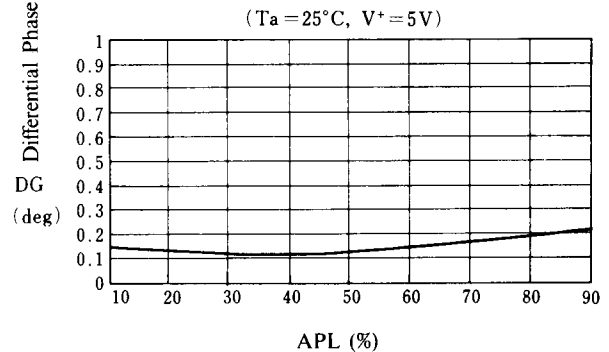

■ TYPICAL CHARACTERISTICS (Ta = +25°C)

Crosstalk (IN2A to OUT2) vs. Operating Voltage
(Ta = 25°C)

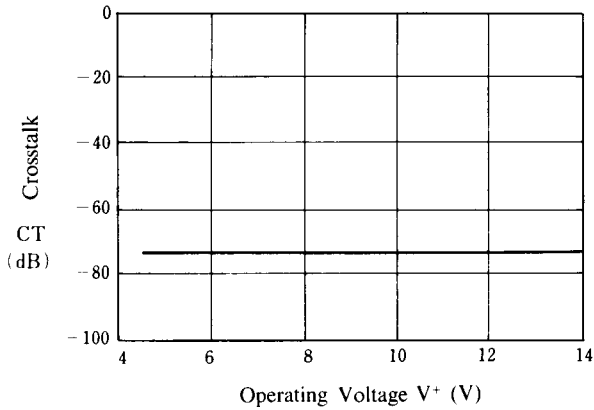

Crosstalk (IN2A to OUT2) vs. Ambient Temperature
(V⁺ = 5V)

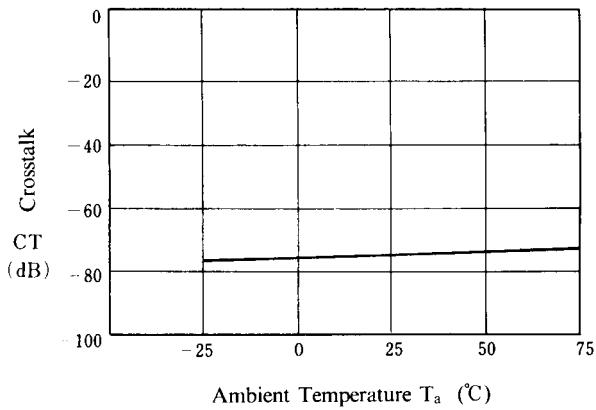

Crosstalk (IN1B to OUT1) vs. Operating Voltage
(Ta = 25°C)

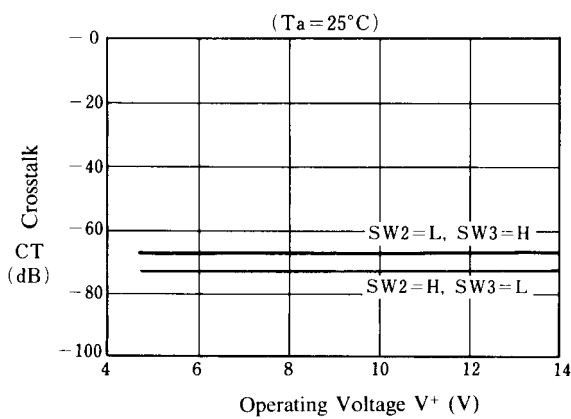

Crosstalk (IN1B to OUT1) vs. Ambient Temperature
(V⁺ = 5V)

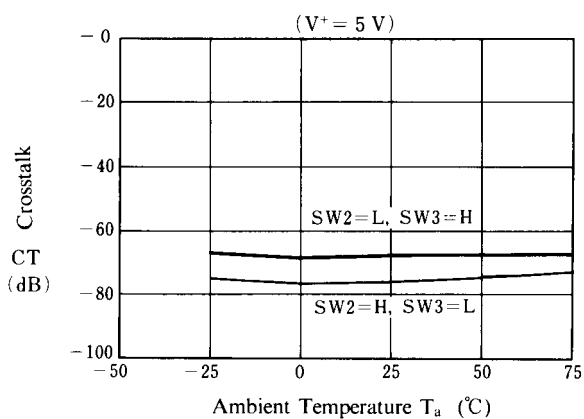

Crosstalk (IN1B to OUT1) vs. Operating Voltage
(Ta = 25°C)

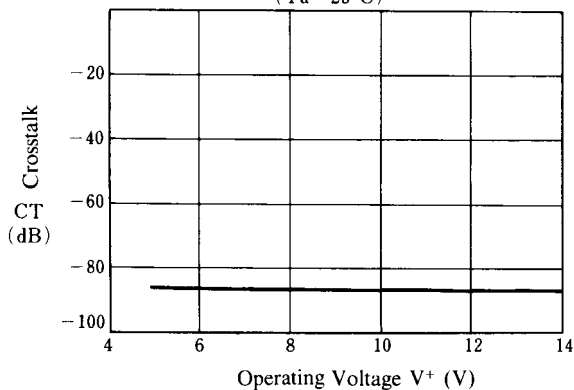

Crosstalk (IN1B to OUT1) vs. Ambient Temperature
(V⁺ = 5V)

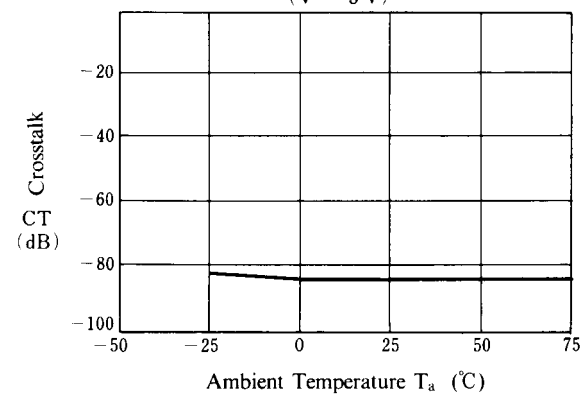

■ TYPICAL CHARACTERISTICS (T_a = +25°C)

Total Harmonic Distortion vs. Load

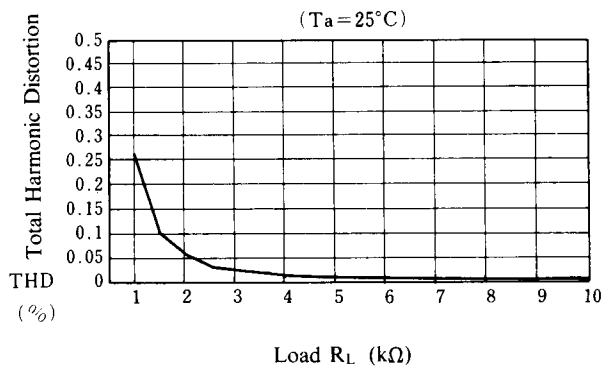

NJM2506

■ APPLICATION

This IC requires $1\text{M}\Omega$ resistance between INPUT and GND pin for clamp type input since the minute current causes an unstable pin voltage.

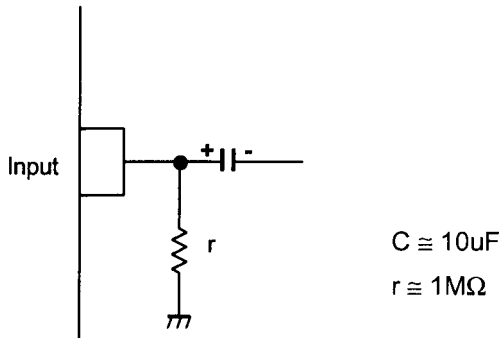

This IC requires $0.1\mu\text{F}$ capacitor between INPUT and GND, $1\text{M}\Omega$ resistance between INPUT and GND for clamp type input at mute mode.

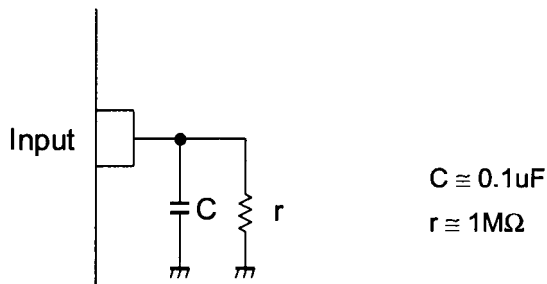

This IC requires $0.1\mu\text{F}$ capacitor between INPUT and GND for bias type input at mute mode.

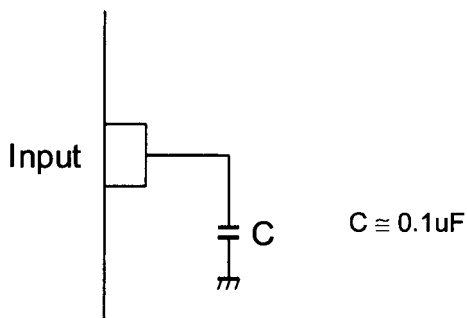

[CAUTION]
The specifications on this databook are only given for information, without any guarantee as regards either mistakes or omissions. The application circuits in this databook are described only to show representative usages of the product and not intended for the guarantee or permission of any right including the industrial rights.